

8.

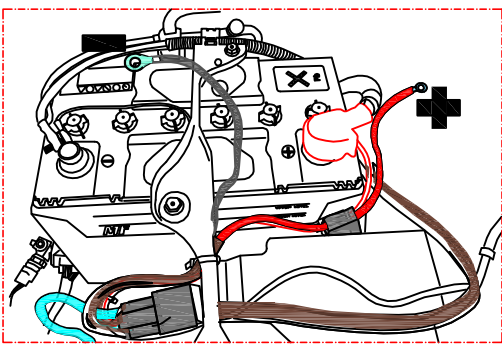

9.

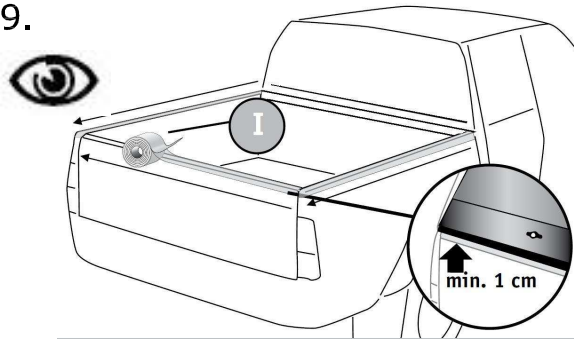

10.

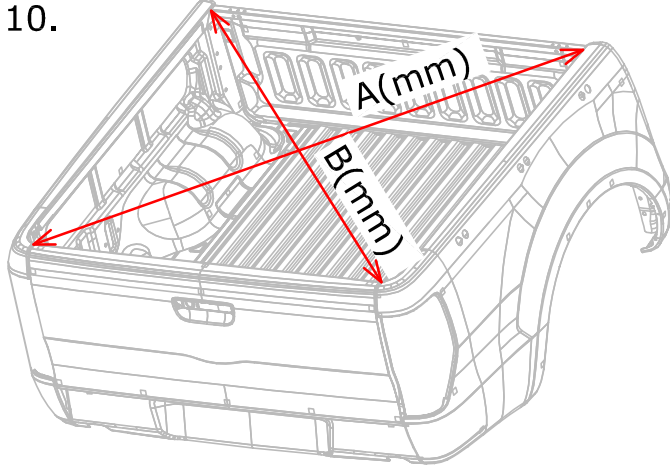

$$A(\text{mm}) = B(\text{mm}) [+/- 3\text{mm}]$$

IMPORTANT!
If $A(\text{mm}) \neq B(\text{mm}) [+/- 3\text{mm}]$ please contact Road Ranger company.

ACHTUNG!
Wenn $A(\text{mm}) \neq B(\text{mm}) [+/- 3\text{mm}]$ bitte Kontakt mit Road Ranger aufnehmen.

11.

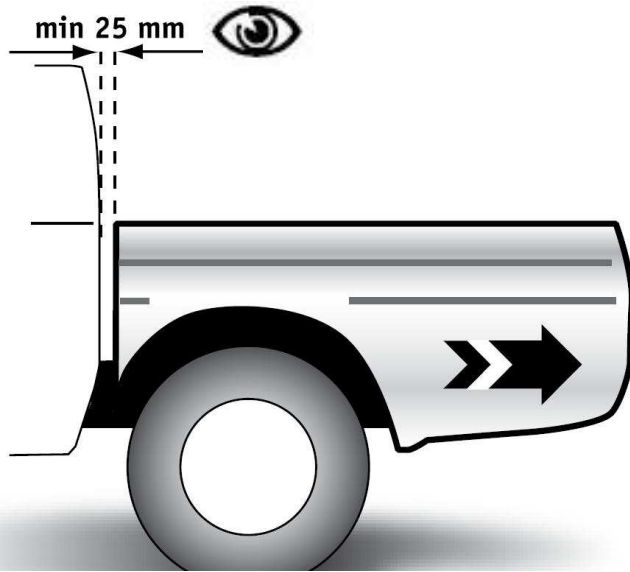

12.

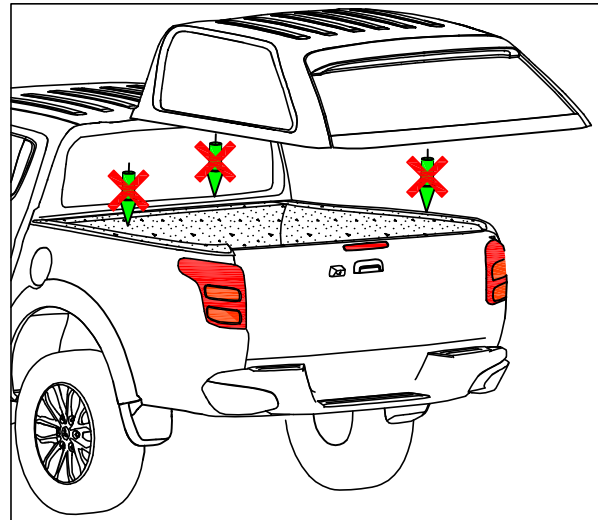

Bitte das Hardtop auf der Überkante Ladewanne nicht montieren!!!

Don` t install on over rail bedliner!!!

13.

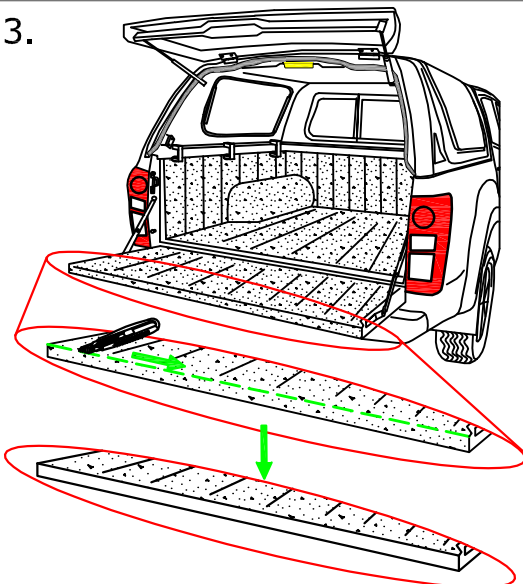

14.

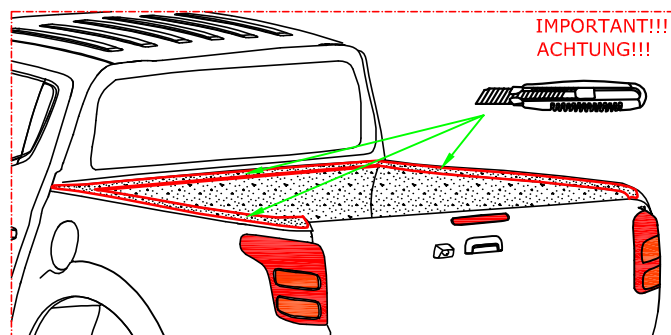

Montageanleitung >> Инструкция по установке >>

A.

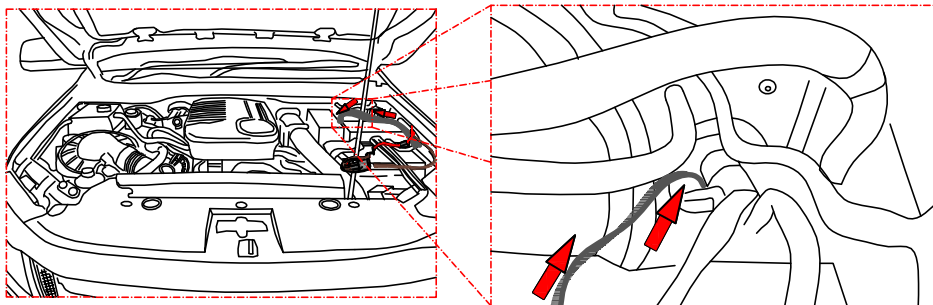

B.

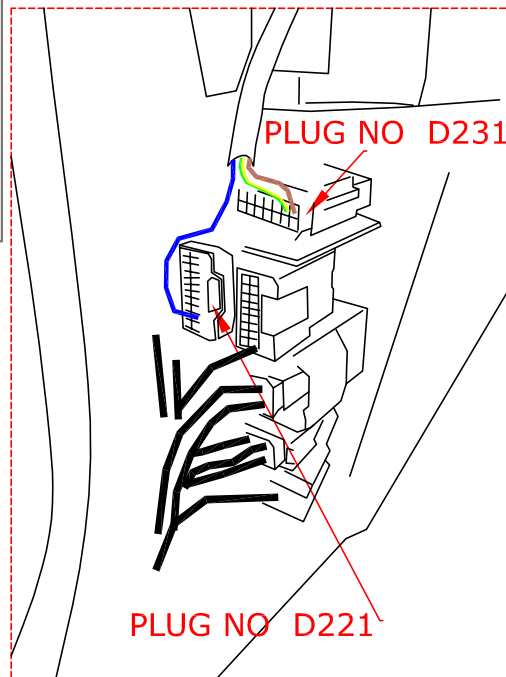
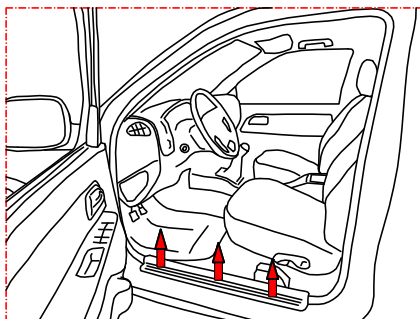

C.

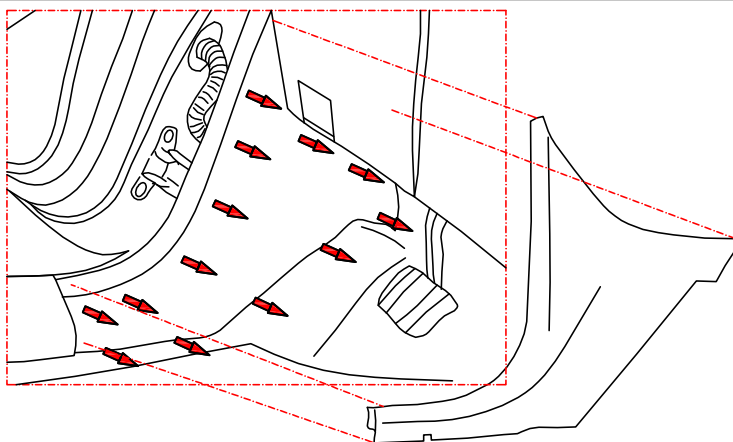

D.

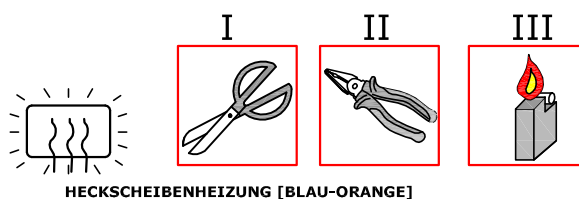
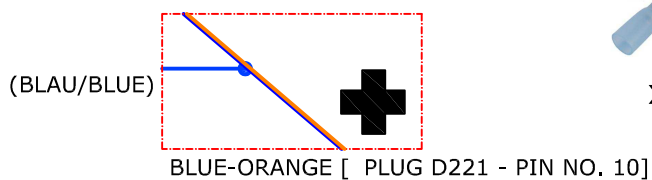
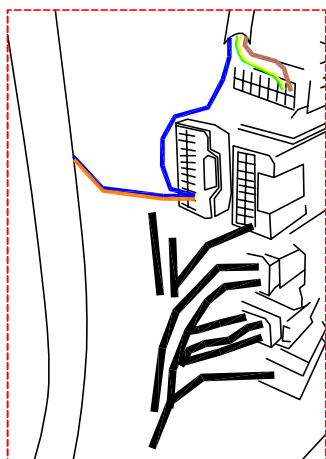

E.

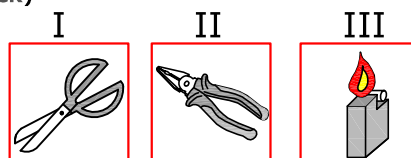
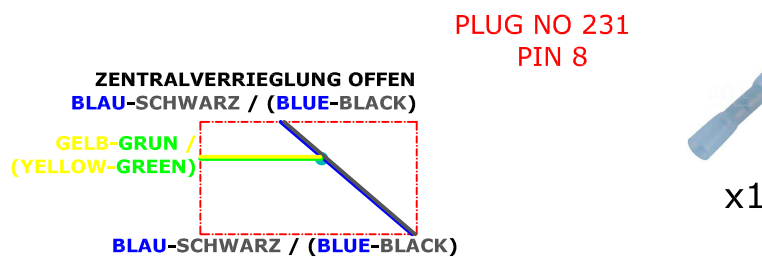
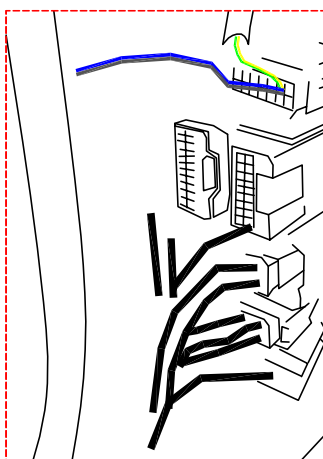

Montageanleitung >> Инструкция по установке >>

Installation instruction >> Instruções de montagem >> Instruzioni di montaggio >> Instruções de montagem >> Montageanvising >> Instruções de montagem >> Instruções de montagem

Montageanleitung >> Инструкция по установке >> Montageanleitung >> Instruções de Montagem

Installation instruction >> Instructions de montage >> Istruzioni di montaggio >> Instruções de montagem >> Montageanvising >> Instruções de Montagem

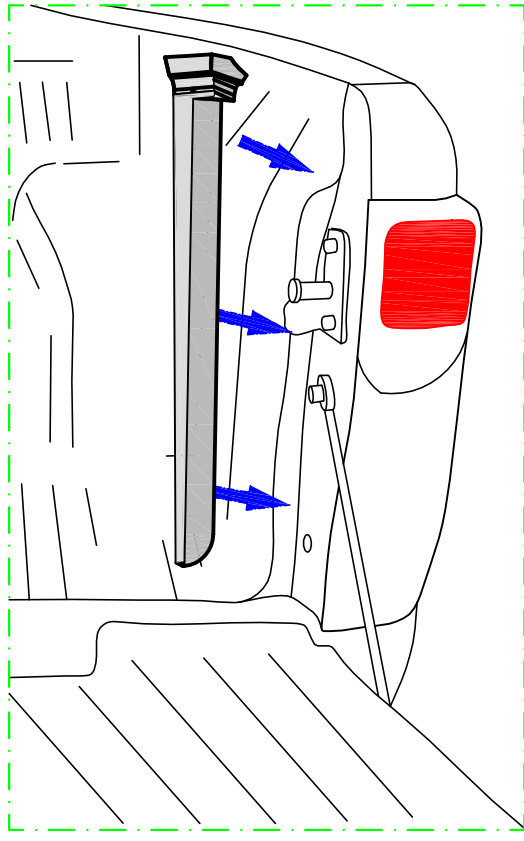
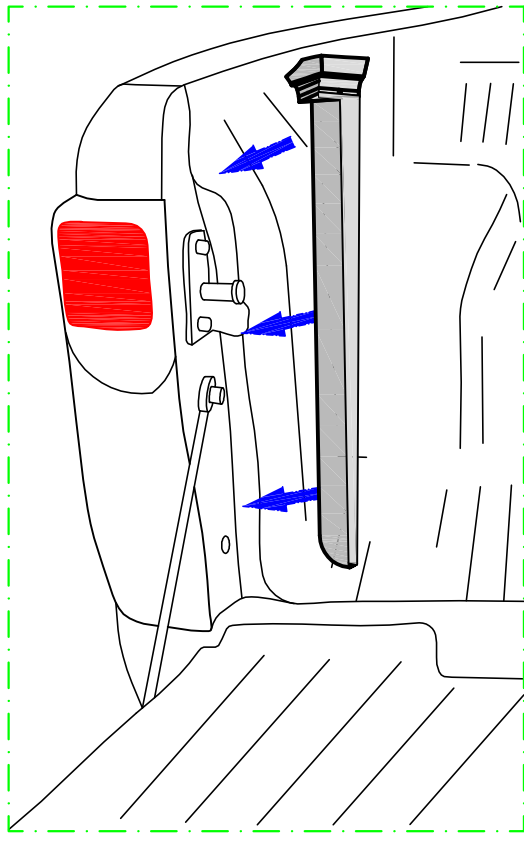
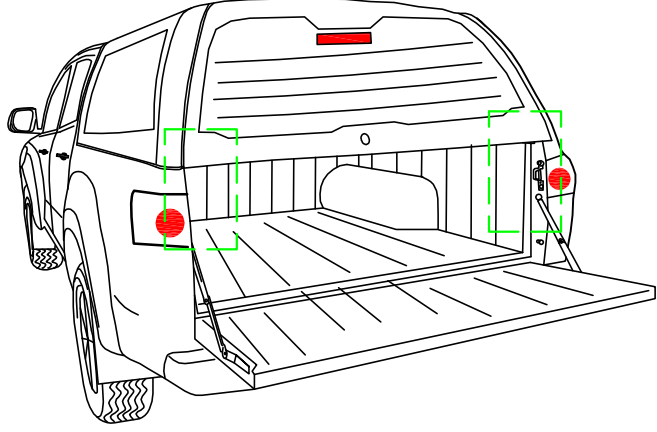
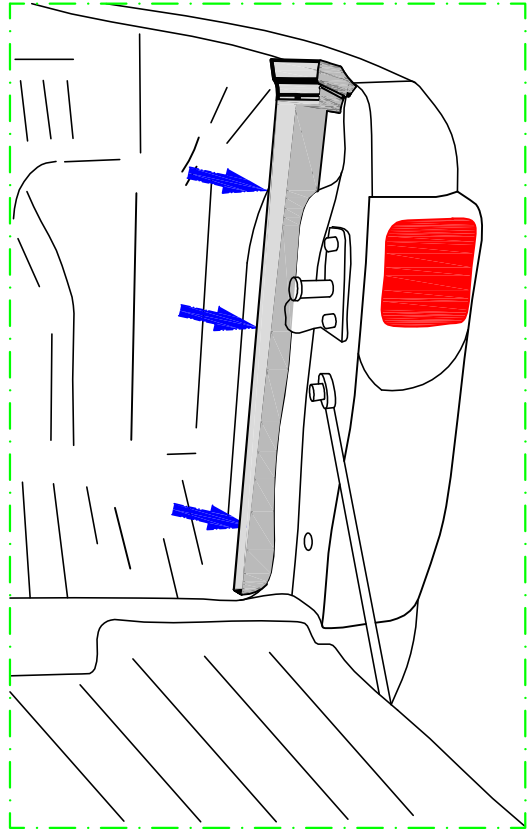
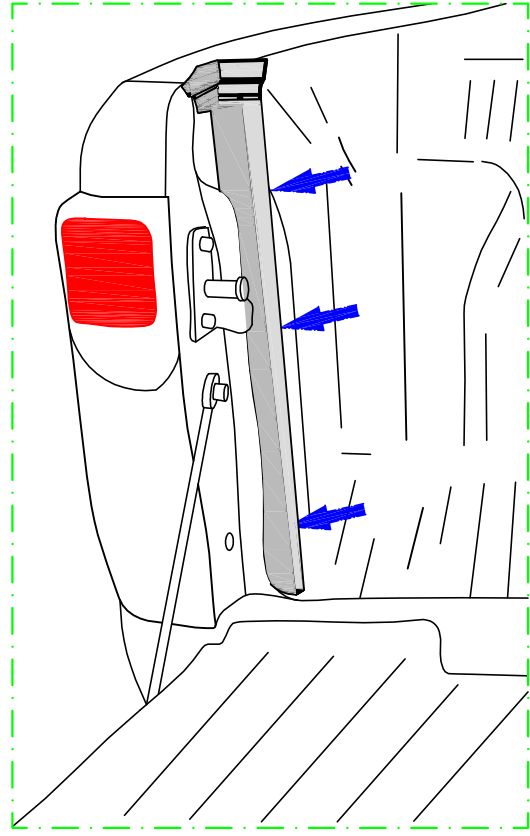

I

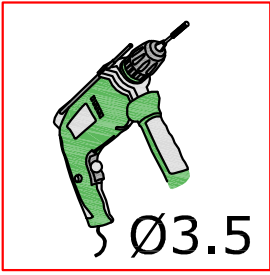

II

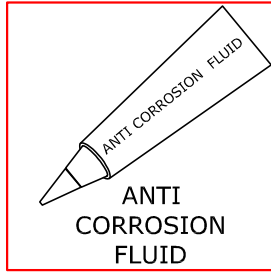

III

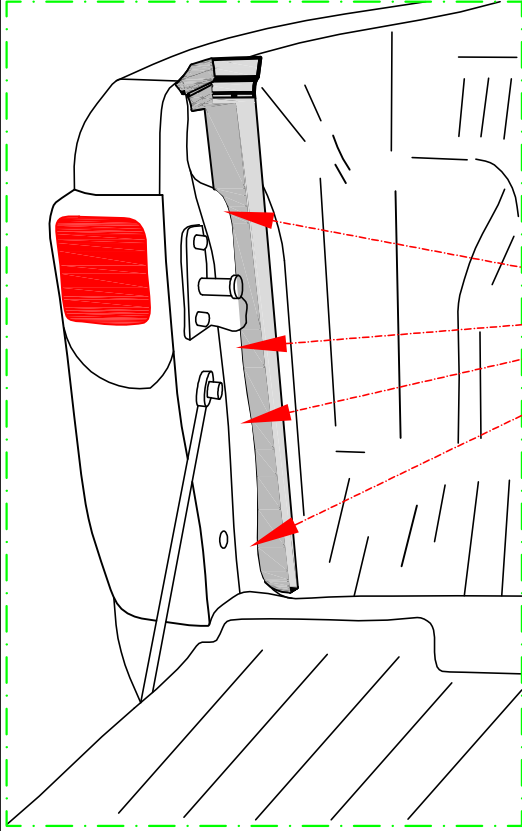
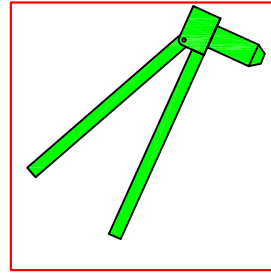

I

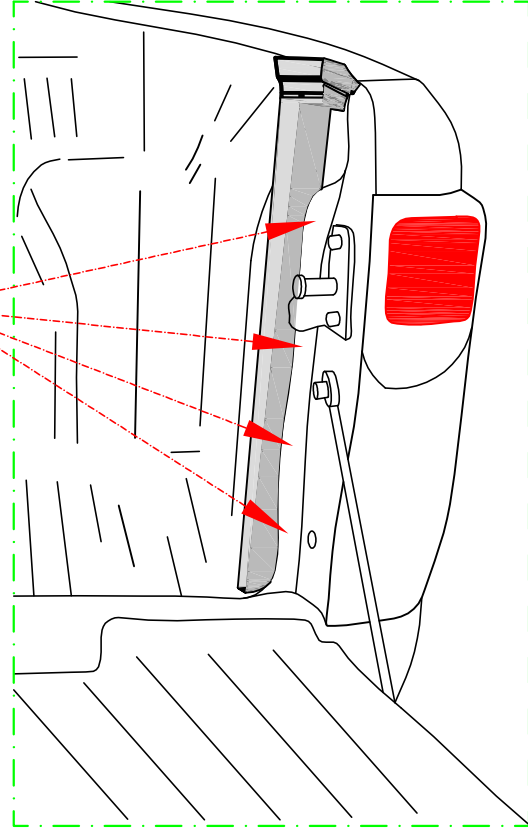
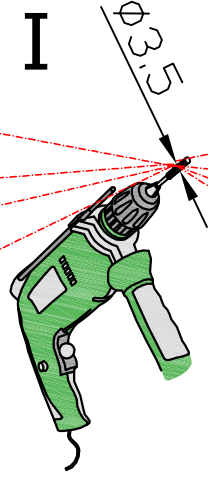

II

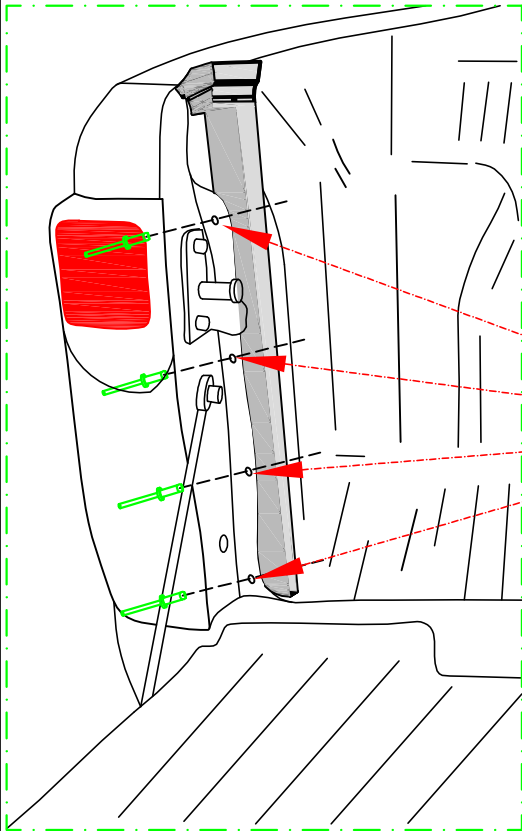
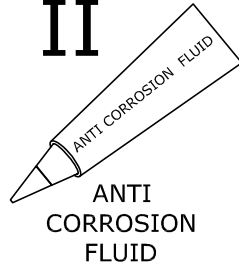

III

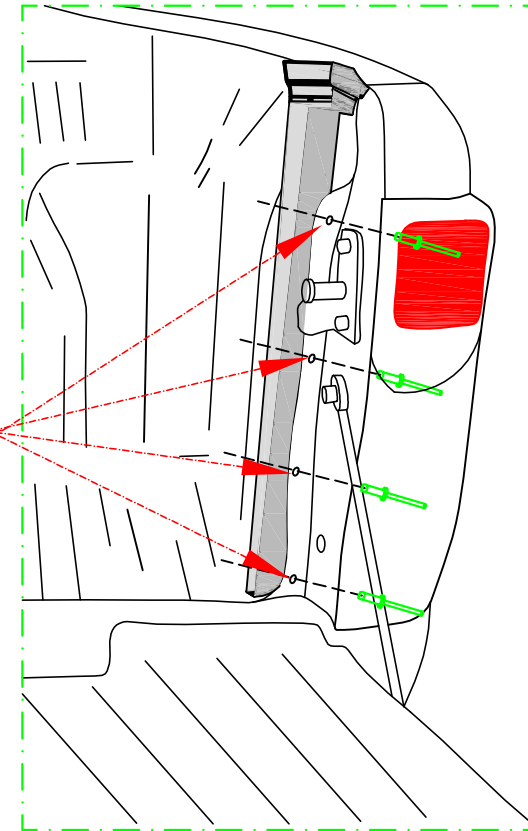
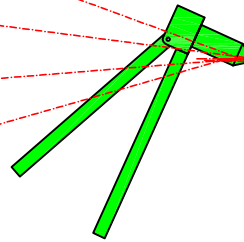

x8

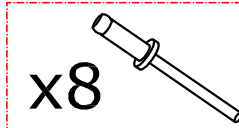

Montageanleitung >> Инструкция по установке >>

Montageanleitung >> Инструкция по установке >>

Installation instruction >> Instructions de montage >> Istruzioni di montaggio >> Instrucciones de montaje >> Montageanvisning >> Instruções de Montagem

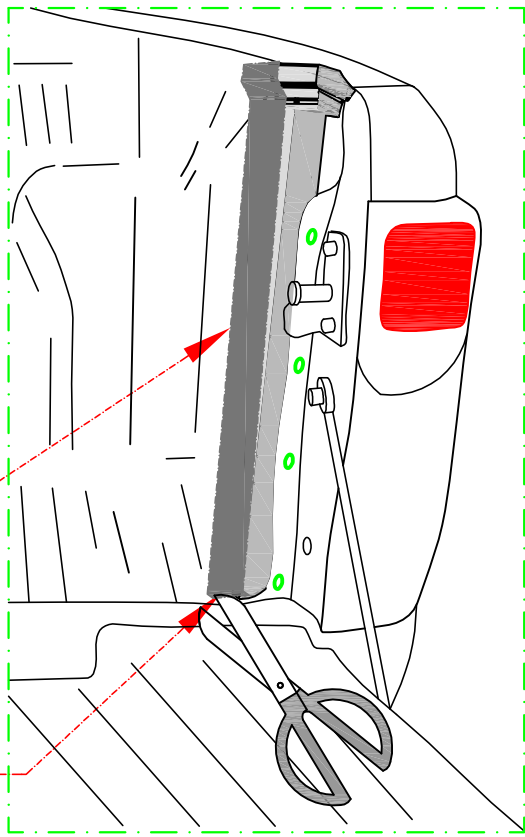
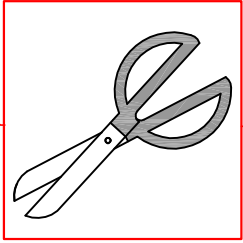
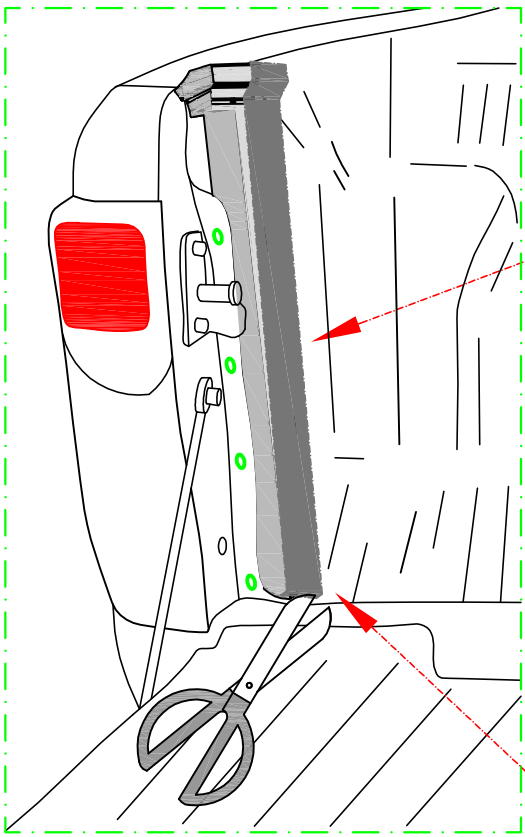
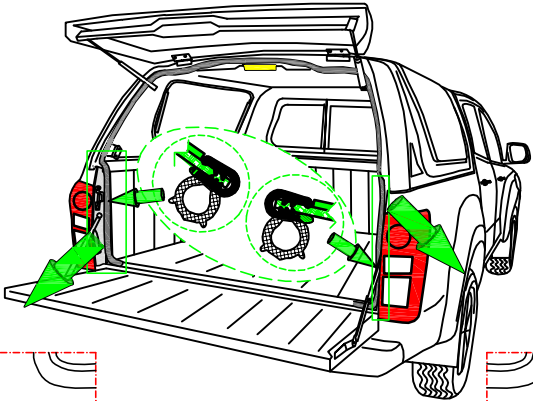
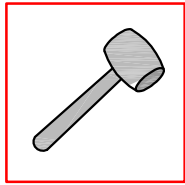
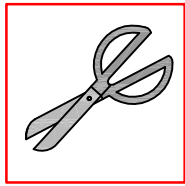
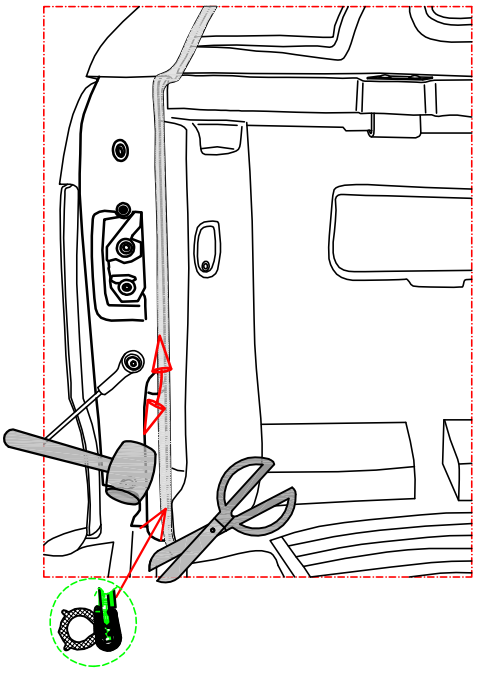

MANUELLE ENTRIEGELUNG / MANUAL UNLOCKING / OTWIERANIE KLUCZEM:

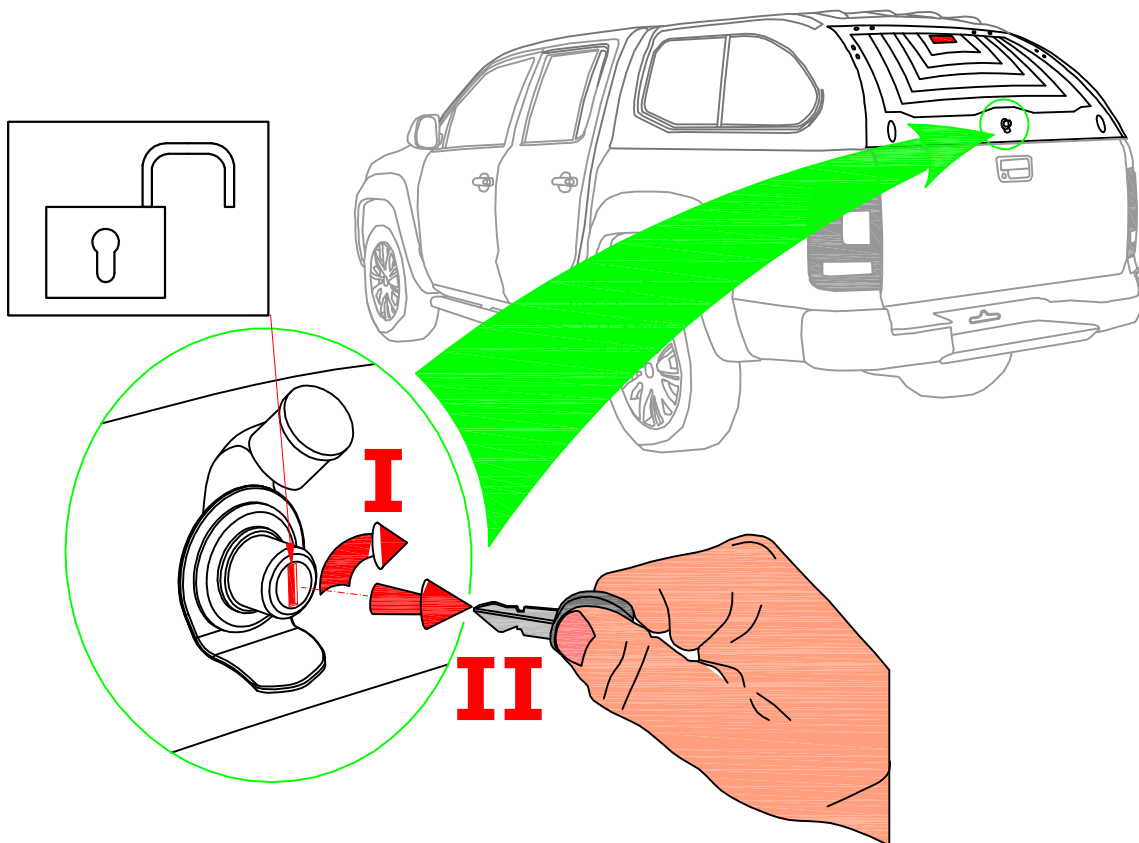

MANUELLE VERRIEGELUNG / MANUAL LOCKING / ZAMYKANIE KLUCZEM:

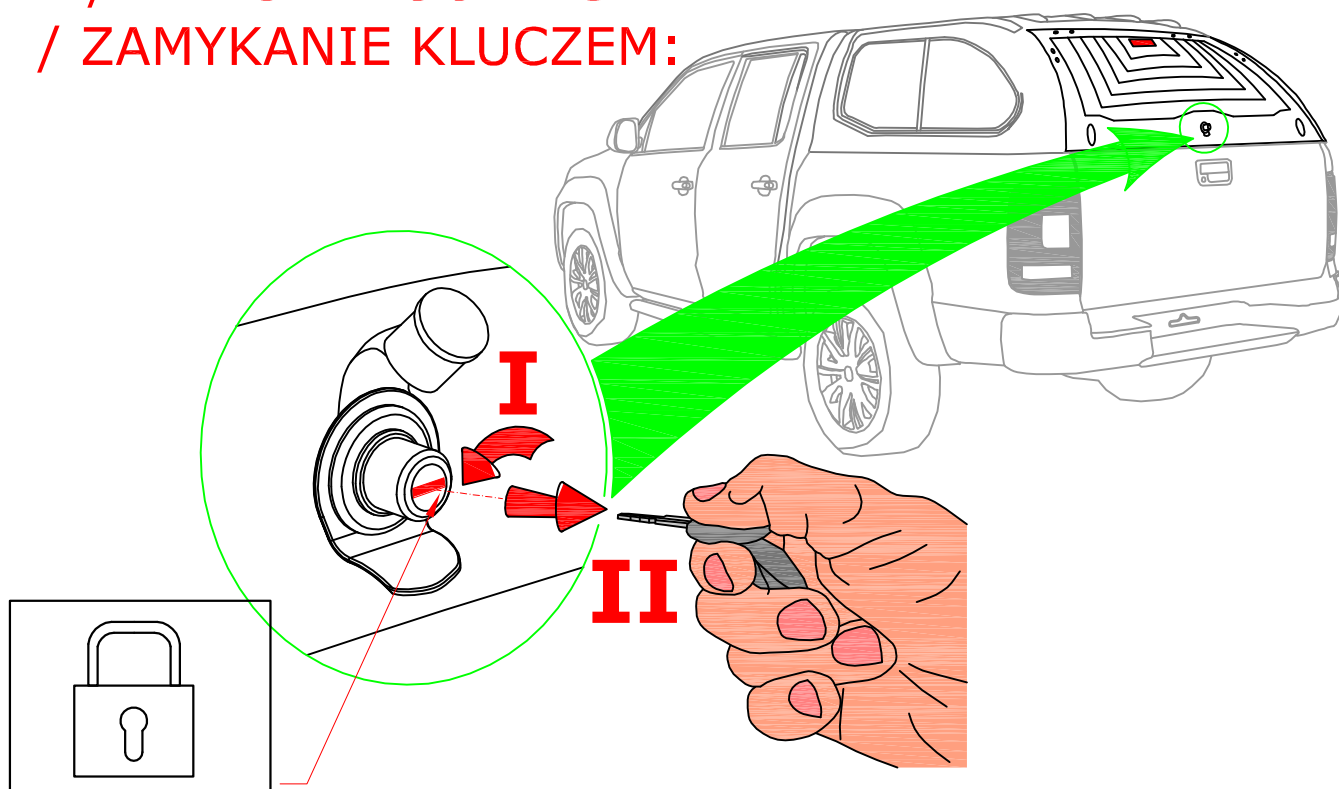

FERNENTRIEGELUNG / REMOTE CONTROL UNLOCKING / OTWIERANIE ZDALNE

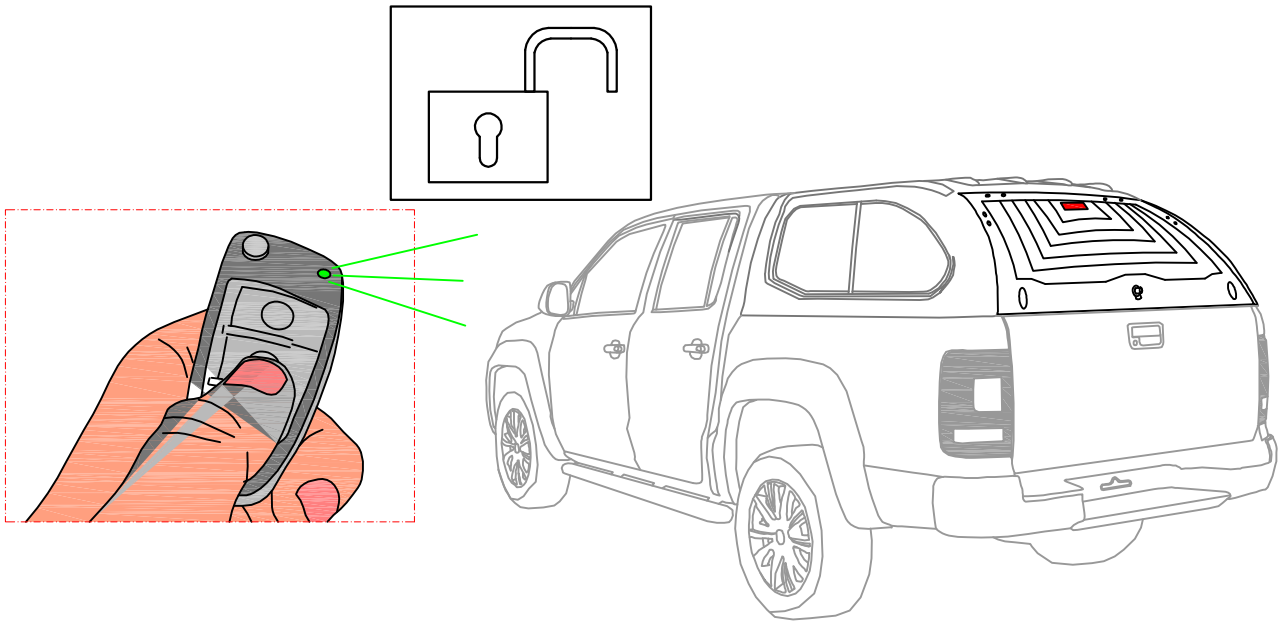

FERNVERRIEGELUNG / REMOTE CONTROL LOCKING / ZAMYKANIE ZDALNE

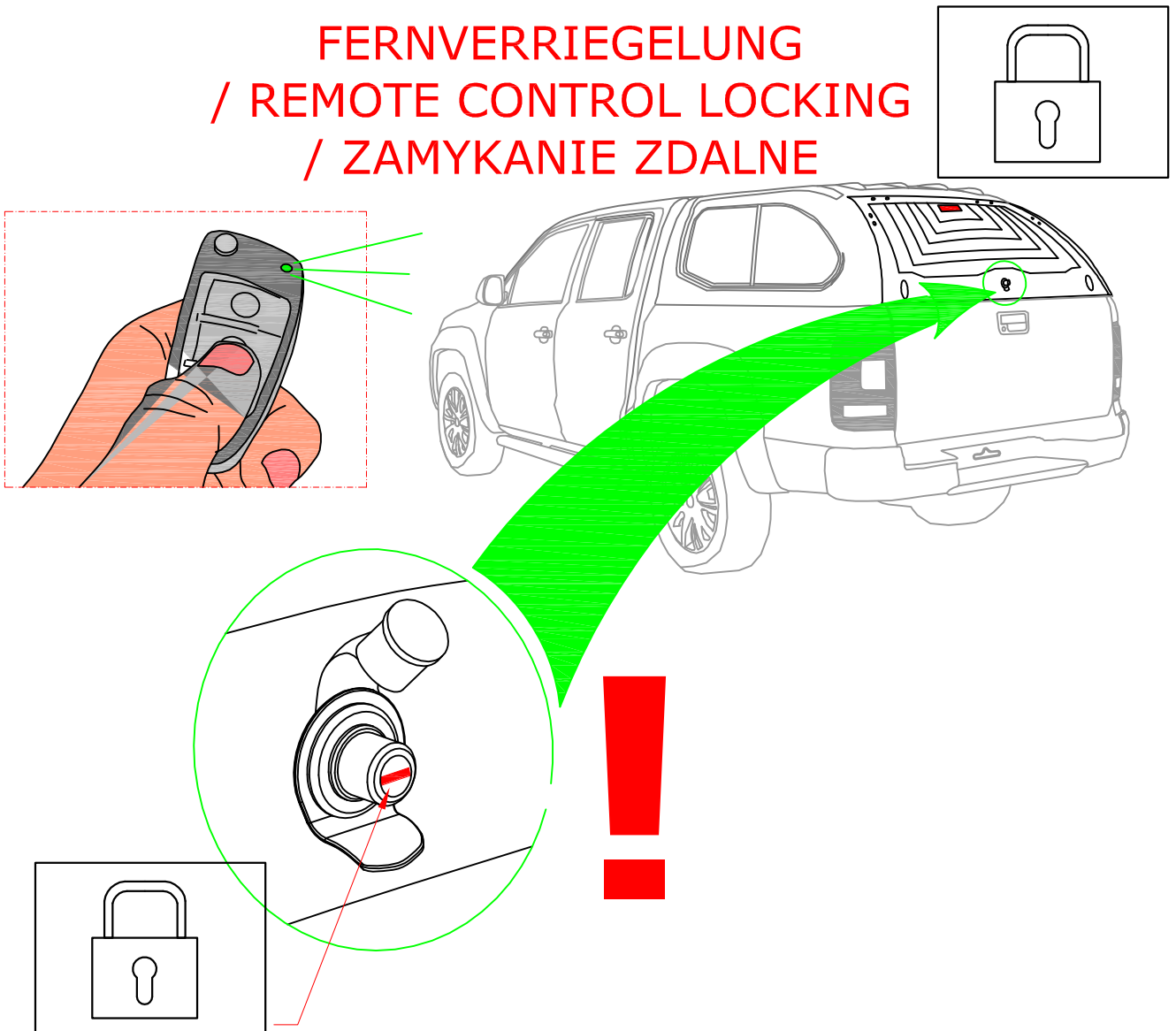

LINKE SEITENKLAPPE / LEFT SIDE DOOR / KLAPA BOCZNA LEWA

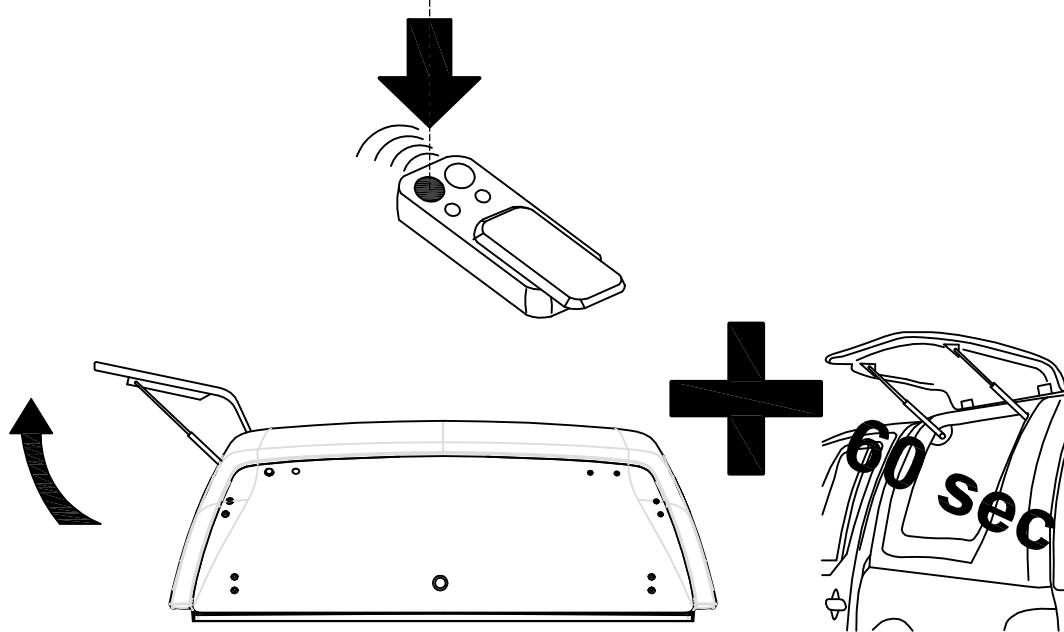

Beim oeffnen der Seitenklappe schaltet sich die Innenleuchte automatisch fuer 60 sekunden ein.
/ Press left remote controller button to open left side door and to turn on the internal light for 60 sec.
/ Przycisk ten otwiera lewą klapę boczną i jednocześnie załącza oświetlenie wewnątrz nadbudowy na 60 sek.

RECHTE SEITENKLAPPE / RIGHT SIDE DOOR / PRAWA KLAPA BOCZNA

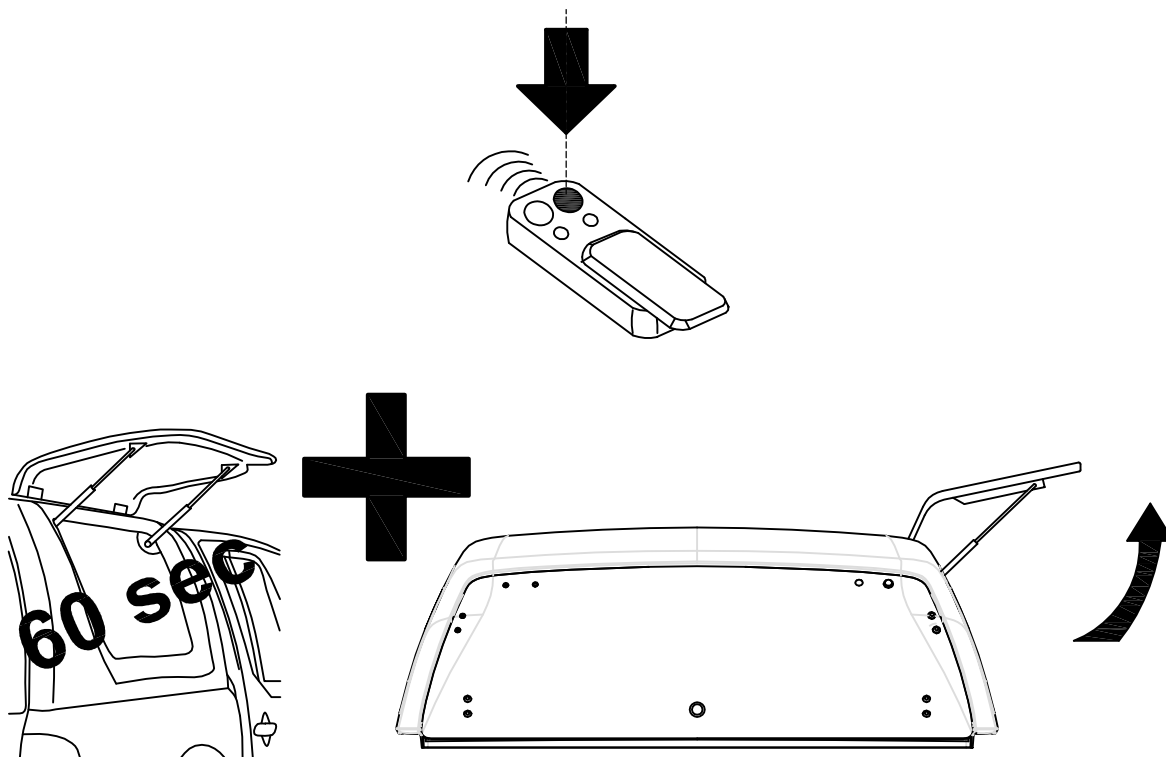

Beim oeffnen der Seitenklappe schaltet sich die Innenleuchte automatisch fuer 60 sekunden ein.
/ Press right remote controller button to open right side door and to turn on the internal light for 60 sec.
/ Przycisk ten otwiera prawą klapę boczną i jednocześnie załącza oświetlenie wewnątrz nadbudowy na ok 60 sek.

FIAT FULLBACK 2016

*) S2 version only

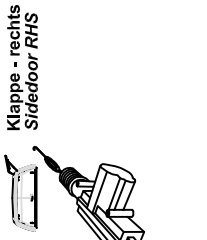
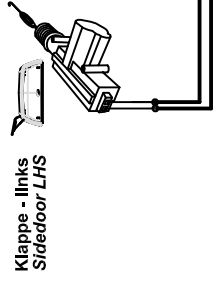

SCHWERKRAFT-SENSOR-LEUCHTEN
IM INNEREN

Innenleuchte
/ Interior light

BRAUN
ROT
GELB
SCHWARTZ

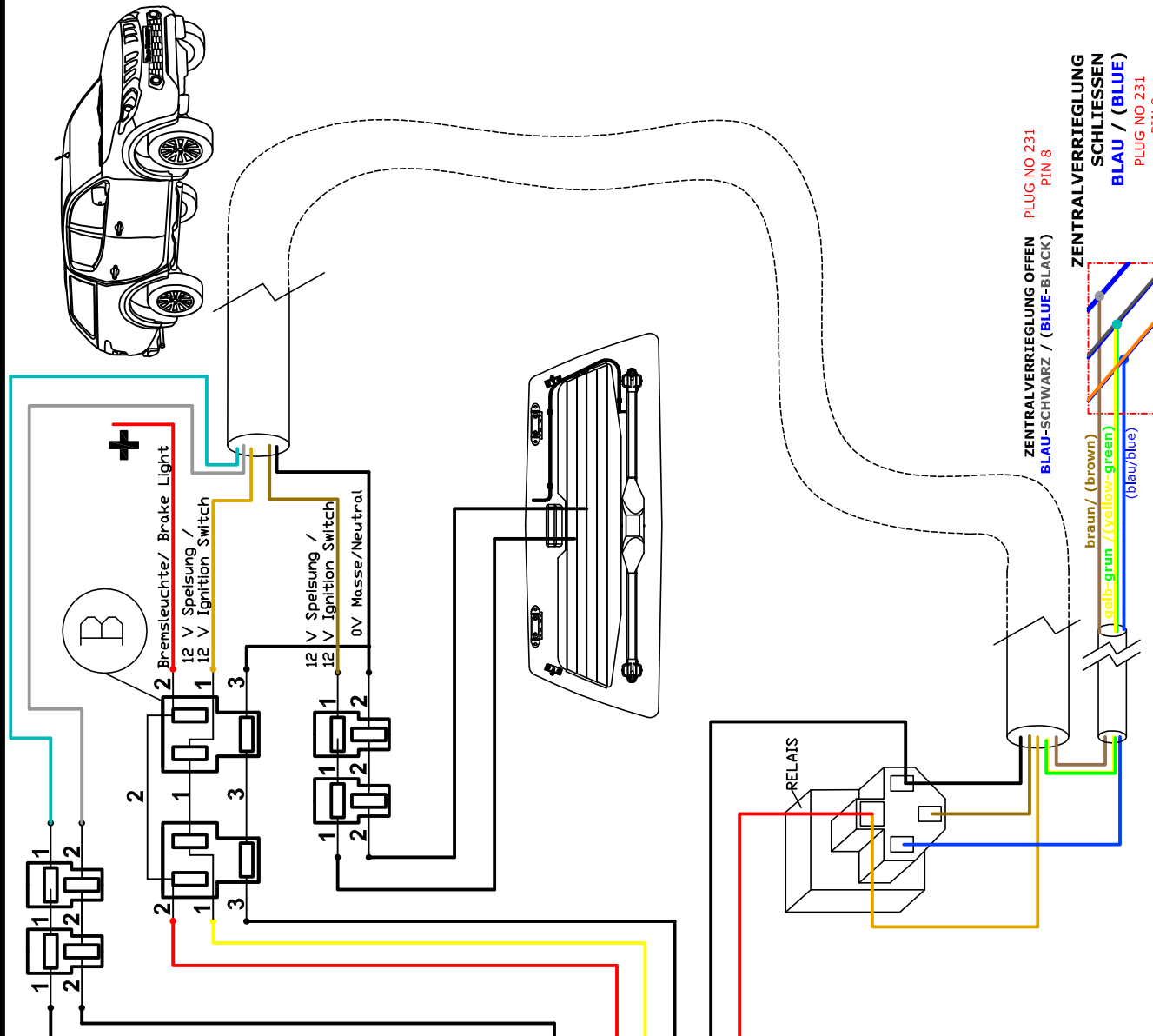
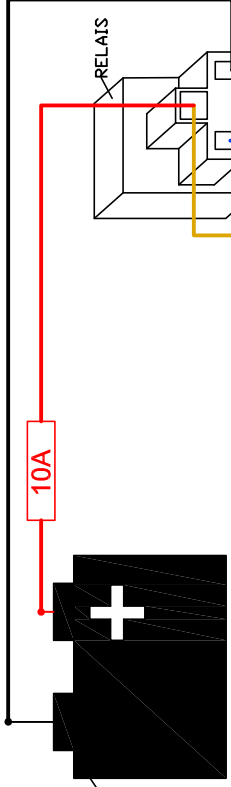

ZENTRALVERRIEGLUNG OFFEN
PLUG NO 231
BLAU-SCHWARZ / (BLUE-BLACK)
PIN 8

ZENTRALVERRIEGLUNG
SCHLIESSEN
BLAU / (BLUE)
PLUG NO 231
PIN 9

braun / (brown)
gelb-grun / (yellow-green)
(blau/blue)

HECKSCHEIBENHEIZUNG [BLAU-ORANGE] - [PLUG D221 - PIN NO. 10]

Montageanleitung >> Инструкция по установке >>

Installation instruction >> Istruzioni di montaggio >> Instrucciones de montaje >> Montageanvising >> Instruções de Montagem